

Superior quality since
1984

Owners Manual

PEDESTAL DRILL PRESS

BORUM

INDUSTRIAL WORKSHOP EQUIPMENT

**INDUSTRIAL
QUALITY**



Specifications:

- Motor: 240V 3/4HP
- Number of Speeds: 16
- Spindle Speeds: 162-3000rpm
- Maximum Drilling Capacity: 16mm
- Spindle Taper: MT2
- Chuck: 16mm
- Maximum Spindle Stroke: 78mm
- Swing: 350mm
- Maximum Distance from Spindle to Table: 781mm
- Maximum Distance from Spindle to Base: 1219mm
- Diameter of Column: 73mm
- Diameter of Table: 290mm
- Size of Base: 450 x 265mm
- Overall Height: 1588mm
- Weight: 55kg

About the Borum brand

Our **“heavy duty commercial”** range of **Borum Industrial** equipment has been manufactured to exacting standards for the past **34 years**. We specify industrial quality components and design to ensure a long and durable working life in **commercial transport, mining, earthmoving and railway** environments. Our **Borum Industrial** range of equipment is focused on achieving superior professional standards, reliability, quality, and are covered by a **12 month trade use warranty**.

WARNING INFORMATION



IMPORTANT: READ ALL INSTRUCTIONS BEFORE USE

! WARNING

The instructions and warnings contained in this manual should be read and understood before using or operating this equipment. Do not allow anyone to use or operate this equipment until they have read this manual and have developed a thorough understanding of how this equipment works. Failure to observe any of the instructions contained in the manual could result in severe personal injury to the user or bystanders, or cause damage to the equipment and property. Keep this manual in a convenient and safe place for future reference.

The warnings, cautions and instructions discussed in this instruction manual cannot cover all possible conditions and situations that may occur. It must be understood by the operator that common sense and caution are factors which cannot be built into this product, but must be supplied by the operator.

Whilst every effort has been made to ensure accuracy of information contained in this manual, the Borum policy of continuous improvement determines the right to make modifications without prior warning.

CONTENTS

WARNING INFORMATION..... 1

CONTENTS..... 1

STANDARD OPERATING PROCEDURE 2

ASSEMBLY, OPERATION, PREVENTITIVE MAINTENANCE..... 3

PARTS LIST..... 9

PARTS DIAGRAM 10

TROUBLESHOOTING..... 11

WARRANTY..... 12

STANDARD OPERATING PROCEDURE

DO NOT use this machine unless you have been trained and assessed to a competent level in its safe use and operation, and have been given permission to use this



Safety glasses must be worn when operating this equipment



Long loose hair must be contained when operating this equipment



Safety footwear must be worn when operating this equipment



Close fitting/protective clothing must be worn when operating this equipment



Rings and jewellery must not be worn when operating this equipment



Hearing protection must be worn where noise levels are in excess of 85 dB(A) occupational exposure limit



Gloves must not be worn when machine is operating. Machine to be at standstill if gloves required for manual

PRE-OPERATIONAL SAFETY CHECKS

1. Keep guards in place and in good working order
2. Keep drill press in good working order, follow lubricating and changing accessories instructions
3. Use recommended accessories only, failure to do so may damage the drill press and/or may risk injury
4. Remove adjusting keys & wrenches from the drill press before operating
5. Ensure the switch is in the OFF position before starting the drill press
6. Disconnect drill press before performing any maintenance
7. Keep work area clean, free from hazards and well lit.
8. Only use the drill press for its intended purpose.
9. Wear the correct PPE clothing.
10. Secure work using clamps or vice where practical.
11. Do not overreach, keep proper footing and balance at all times while operating the drill press
12. Never leave drill press running unattended, always lock the "on - off" switch when not in use
13. Use only on hard level surfaces capable of sustaining the load.
14. Ensure that risk assessment has been read.
15. Check workspace and walkways to ensure no slip-hazards are present.
16. Faulty equipment must not be used. Immediately report suspect equipment.

OPERATIONAL SAFETY CHECKS

1. Never leave the machine running unattended.
2. Before making adjustments or before cleaning sward accumulations switch off and bring the machine to a complete standstill.
3. Ensure that the work piece is securely held in a clamped work vice or clamped directly to the table.
4. Feed downwards at a sufficient rate to keep the drill cutting.
5. Feed with care as the drill breaks through the underside of the work.
6. Use a safe working posture (beware of hair catching).

HOUSEKEEPING

1. Switch off the machine.
2. Return all tooling and fixtures to the correct storage location.
3. Display a completed "Equipment in Use" notice if the machine is set up and/or in use but unattended.
4. Leave the machine and work area in a safe, clean and tidy state after job is completed.
5. Return surplus material to stock and dispose of waste material in an appropriate recycling or waste bin.

POTENTIAL HAZARDS

- Hair/clothing entanglement – rotating spindle/drill
- Eye injuries
- High noise levels when drilling some materials
- Removal or modification of safety devices
- Flying swarf/chips
- Sharp edges and burrs
- Distracting operator
- Using equipment with lapsed test tag

ASSEMBLY, OPERATION, PREVENTITIVE MAINTENANCE

1. FEATURES & MODELS

This "Borum Industrial Drill Press" delivers precision and power... and is designed to handle the demands of a professional workshop environment. With a powerful long-life industrial quality 3/4 HP motor (that's fully enclosed in a durable metal hood) double-wide spindle bearings and a precision spindle, this is one very reliable drilling machine.

Equipped with 16 drilling speeds from 162 to 3,000rpm and a 16mm drilling capacity this robust and user-friendly drill press is ideal for a busy maintenance workshop or small production factory.

Perfect for fabricators looking for a drill press that's rugged enough to handle the demands of light and medium duty production work and accurate enough to consistently deliver precise results.

2. ASSEMBLY

Fig 1. Column Assembly

1. Place column assembly on base and align holes on column support with holes on base.
2. Secure the column with 4 bolts and washers (provided)

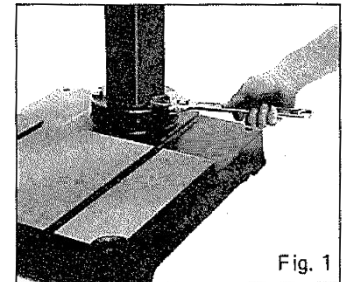

Fig 2. Table Bracket Installation

1. Remove collar and rack
2. Install table bracket and rack

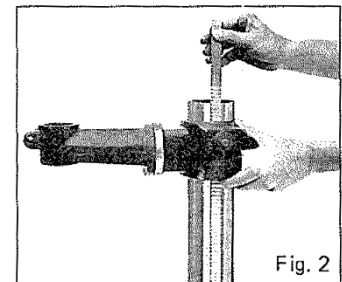

Fig 3. Collar Installation

1. Install collar and tighten firmly

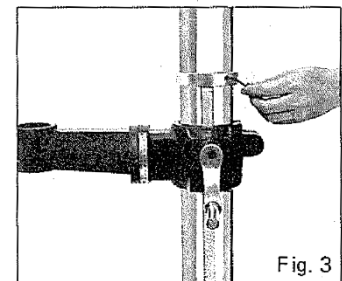

Fig 4. Bracket Installation

1. Install bracket, handle and clamp bolt
2. Tighten handle with attached set screw

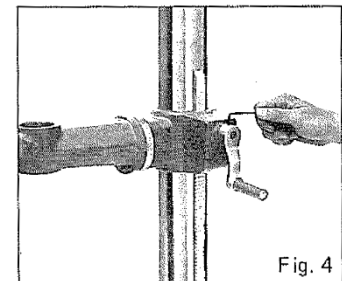

Fig 5.

1. Install clamp bolt to tighten

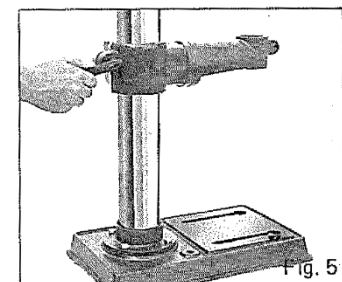

Fig 6.

1. Install table and clamp with bolt (provided)

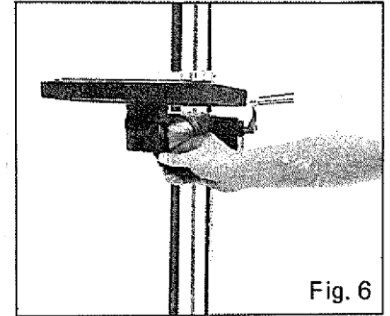

Fig. 6

Fig 7. Head Assembly

1. Position the head assembly over the column and slide into position. Align head frame with table base
2. Fix set screws on right side of head to lock head into position, tighten screws with allen key

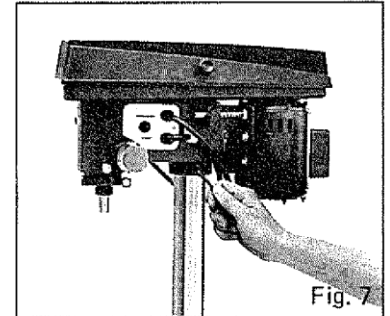

Fig. 7

Fig 8. Feeding Handle Installation

1. Screw knob on each feeding handle, install onto hub of pinion shaft

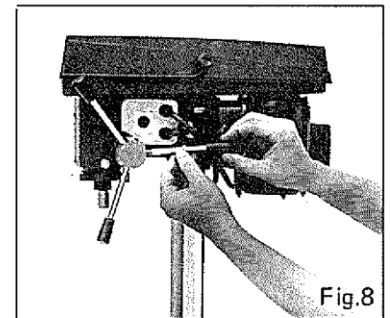

Fig.8

Fig 9. Arbor & Chuck Installation

1. Insert Arbor onto spindle. Pull feed handle down to press arbor into position
2. Open chuck jaws completely by turning attached chuck key counter-clockwise to the end.
3. Place a piece of wood on the table to protect chuck nose

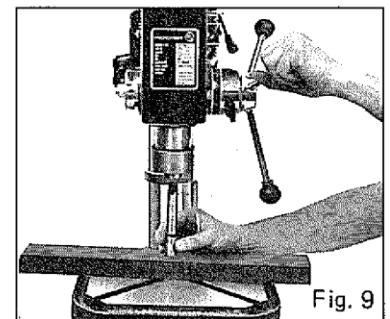

Fig. 9

Fig 10.

1. Install the chuck to the arbor and tighten

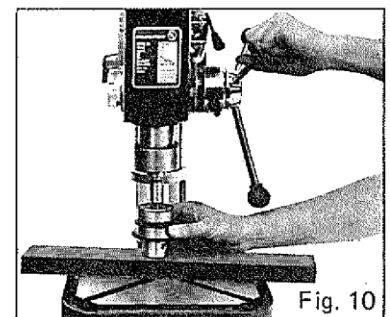

Fig. 10

Fig 11.

1. Install the knob and screw of upper pulley cover

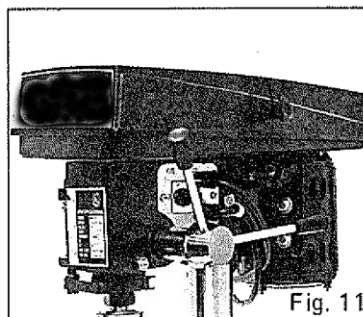

Fig. 11

! Ensure the drill press is firmly fixed in place to table or floor following assembly

Table Adjustment

Fig 12. Height Adjustment

1. To adjust up or down, loosen the clamp bolt to adjust the table the preferred position by turning the table bracket handle

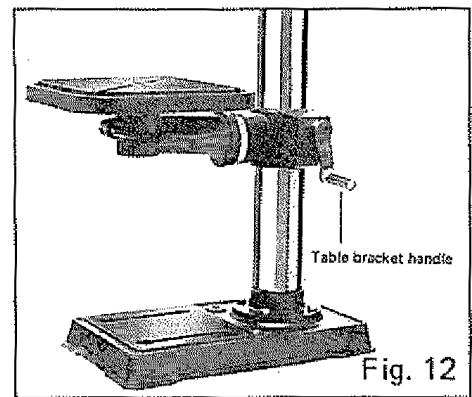

Fig 13. Tilting Adjustment

1. Loosen the table bevel lock bolt with an adjustable wrench
2. Tilt the table to the preferred angle and re-tighten the bolt

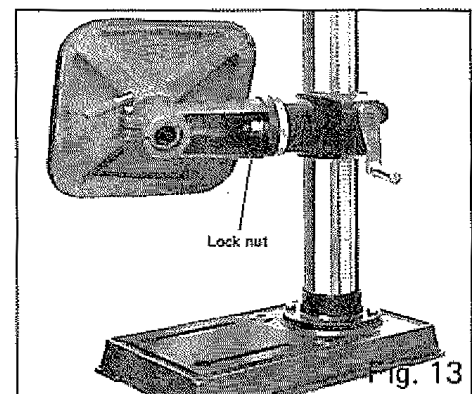

Fig 14. Swing 360°

1. Loosen the clamp bolt and swing table to preferred position, re-tighten clamp bolt

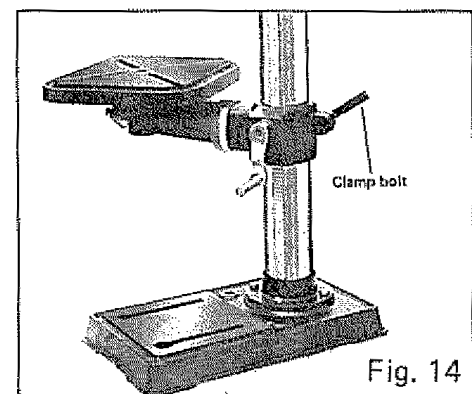
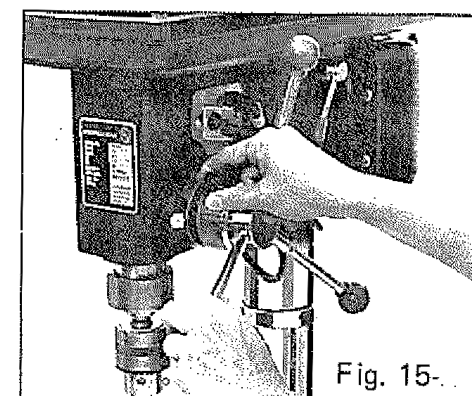

Fig 15 Feed Depth Adjustment

1. Depth control scale sleeve type
2. Loosen the clamp bolt and move to the preferred depth, re-tighten the clamp bolt



Speed Adjustment

Fig 16-1 Speed Adjustment

1. Open the pulley case and loosen the belt tension lock handle
2. Choose speed for drilling operation and move belt to correct position for preferred speed
3. Push motor backward until moderate belt tension as required.
4. Re-tighten the lock handle. 16-1 & 16-2

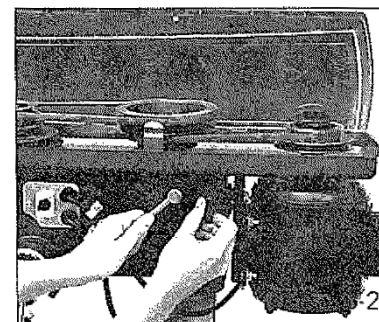
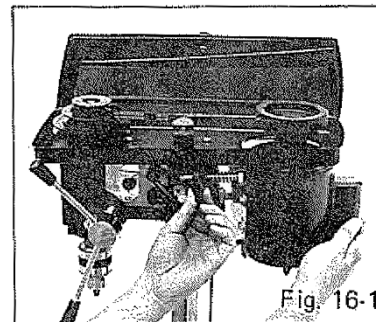

Drilling Speed (Approximately)

Size Diameter		Cast Steel		Tool Steel		Cast Iron		Mild Steel		Alum. & Copper	
		Cutting Speed									
		m/min	ft/min	m/min	ft/min	m/min	ft/min	m/min	ft/min	m/min	ft/min
		12	40	18	60	24	80	30	100	60	200
mm	Inch	Cutting Speed Revolution Per Minute									
2	1/16	1910	2445	2865	3665	3820	4890	4775	6110	9550	12225
3	1/8	1275	1220	1910	1835	2545	2445	3185	3055	6365	6110
5	3/16	765	815	1145	1220	1530	1630	1910	2035	3820	4075
6	¼	610	610	955	915	1275	1220	1590	1530	3180	3055
8	5/16	480	490	715	735	955	980	1195	1220	2390	2445
10	3/8	380	405	570	610	765	815	955	1020	1910	2035
11	7/16	350	350	520	525	700	700	870	870	1740	1745
13	1/2	300	305	440	460	590	610	735	765	1470	1530
16	5/8	240	245	360	365	480	490	600	610	1200	1220
19	3/4	190	205	285	305	380	405	480	510	955	1020

Belt Tension Adjustment

Correct belt tension: Use 4.5kg's of hand pressure on the belt as shown below. The distance is 1/2" (13mm) + 10%

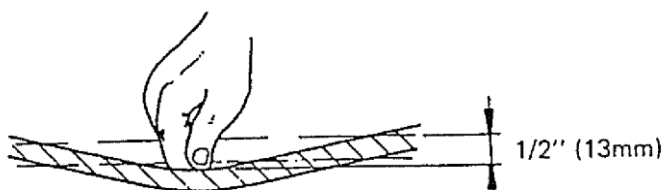

Quill Spring Adjustment

Fig 17 Speed Adjustment

1. Move the stop nuts to the lowest position and lock into place with a wrench to prevent quill dropping while tensioning spring
2. Place screwdriver in lower front notch (A) of spring cap (B) and hold it in place while loosening and removing nuts.
3. Carefully turn screwdriver counter clockwise and engage next notch
4. Tighten inner nut (C) with wrench. DO NOT overtighten as this will restrict quill removal.
5. Move stop nuts to highest position and check tension while turning feed handle. If there isn't enough tension on spring, repeat steps 2 - 4.
6. Check quill while feeding for: Smooth and unrestricted movement. If movement is too tight slightly loosen nuts until unrestricted.

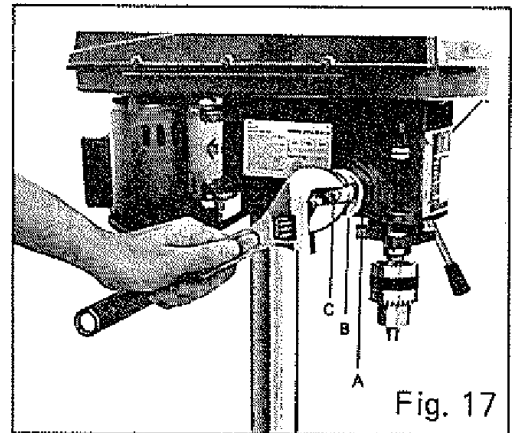

3. BEFORE USE

Prior to each use conduct a visual inspection checking for abnormal conditions, such as cracked welds, leaks, and damaged, loose, or missing parts.

Caution: This drill press is intended for use only with drill bits. The use of other accessories may be hazardous.

Drill Speed: Factors that determine the best speed to use in any drill press operation are:

Type of material being worked on, size of hole, type of drill or cutter and quality of cut desired. The smaller the drill bit, the greater the required RPM. For softer materials, the speed should be higher than firmer material.

Drill Metal: Use clamps to hold work in place when drilling metal. DO NOT hold with hand. The flutes of the drill may seize the work at any time, especially when breaking through stock, causing the work piece to spin.

Clamp: The work must be clamped firmly while drilling: Any tilting, twisting, or shifting results not only in a rough hole, but also increases drill bit breakage. For flat work, lay the piece on a wooden base and clamp firmly down against the table to prevent the work piece from turning. If the piece is of irregular shape and cannot be laid flat on the table, it should be securely blocked and clamped.

Chuck: The chuck should be securely fastened to the spindle. Remove the chuck after adjustment. Only use the chuck key provided by the manufacturer. This chuck key is spring loaded to prevent the chuck key from remaining in the chuck during operation of the drill.

Fixing: Fasten base of drill press to the floor before using to ensure no tipping, sliding of drill press. The set screws of the head frame should be secured tightly before using this machine.

Power: When mounting the motor, ensure the power is disconnected. Connect to power supply protected by a circuit breaker.

Transportation: Lifting by Forklift;

1. If lifting equipment isn't available, use 1ton capacity forklift under the machine base to locate to position
2. To move the drill press safely, place the forks of the forklift at the rear of the drill press – the drill press must only be moved while on a pallet.
3. Keep balance of drill press on pallet while moving with forklift.

4. OPERATION

Fig 18 Installing Drills

1. Insert drill into chuck jaws approx. 1" (25.4mm) long. When using a small drill do not insert too far for the jaws to touch the flutes of the drill. Make sure that the drill is centred in the chuck before tightening the chuck with the key.

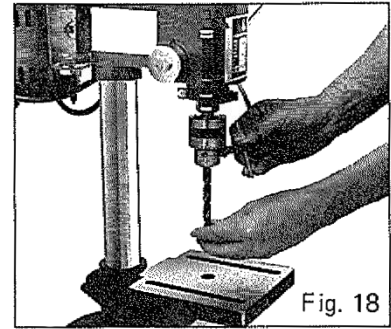

Fig. 18

Fig 19 Workpiece Positioning

1. Always place a piece of wood (or plywood) on the table to prevent "splintering" and/or burrs on the underside of the workpiece as the drill breaks through. Position the wood so that it is in contact with the left side of the column

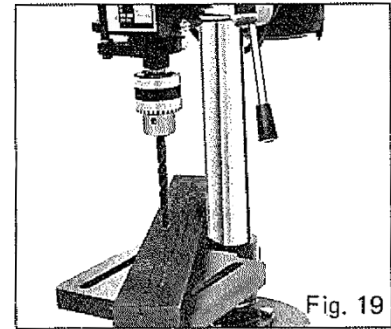

Fig. 19



For small pieces that cannot be clamped to the table, use a drill press vice. The vice must be clamped or bolted to the table.

5. INSPECTION

- Prior to each use conduct a visual inspection checking for abnormal conditions, such as cracked welds, leaks, and damaged, loose, or missing parts.
- The drill press shall always be maintained in accordance with the maintenance instructions. No alterations or modifications shall be made to this drill press.
- Inspections shall be performed in accordance with this owner's manual.
- The drill press must be inspected immediately if it is believed to have been subjected to abnormal load or shock.
- Owners and /or operators should be aware that repair of this product may require specialised equipment and knowledge (refer to maintenance section).

6. STORAGE

This drill press should always be stored in a dry location on a level surface with the power switched off.

7. MAINTENANCE

1. DISCONNECT Drill Press before performing any maintenance
2. FREQUENTLY blow out any dust that may accumulate inside the motor
3. APPLY a coat of automobile type wax or similar to the table and column to keep surface clean
4. LUBRICATION; all the ball bearings are packed with grease at the factory. They require no further lubrication
5. PERIODICALLY lubricate the gear and rack table elevation mechanism, the splines (grooves) in the spindle and the rack (teeth on the quill)
6. Only use replacement parts that are approved by the manufacturer.
7. Regularly clean all surfaces and maintain all labels and warnings.

8. SERVICE & REPAIR

Any Borum Industrial Drill Press found damaged in any way, or found to be worn or operates abnormally should be removed from service until repaired by an authorised service agent. Owners and / or operators should be aware that repair of this product may require specialised equipment and knowledge. Only authorised parts, labels, decals shall be used on this equipment. Annual inspection of the drill press is recommended and can be made by an authorised repair facility to ensure that your equipment is in optimum condition and that the equipment has the correct decals and safety labels specified by the manufacturer.

PARTS LIST

Part #	Description	QTY
1	Base	1
2	Base Flange	1
3	Washer	4
4	Screw	4
5	Column	1
6	Rack	1
7	Screw	1
8	Sleeve	1
9	Shifting Rod	1
10	Set Screw	1
11	Clamp Bolt	1
12	Shaft	1
13	Screw	1
14	Rack Collar	1
15	Scale Sleeve	1
16	Rivet	1
17	Pin	2
18	Knobs	3
19	Feed Handles	3
20	Handle Base	1
21	Feed Pinion	1
22	Scale	2
23	Set Screw	1
25	Set Screw	1
26	Screw Knob	1
27	Cord & Plug	1
28	Spring	1
29	Rod	1
34	Strip Relief	2
35	Cord	1

Part #	Description	QTY
36	Clamp	2
37	Screw	2
40	Motor Label	1
41	Motor	1
42	Set Screw	1
43	Motor Pulley	1
44	V-Belt	1
45	Screw	2
47	Screw	4
49	Screw	2
50	Screw	1
51	Knob	1
52	Pulley Guard (Upper)	1
53	Screw	1
54	Speed Chart	1
55	Switch	1
56	Pulley Guard (Lower)	1
57	Nut	1
58	Spindle Pulley	1
59	Driving Taper Sleeve	1
60	"C" Snap Ring	2
61	Bearing	2
63	Screw	2
64	Rivet	4
65	Switch Plate	1
66	Spring	1
67	Cap	1
68	Nuts	1
69	Name Plate	1
70	Screw	1

Part #	Description	QTY
71	Nut	1
72	Table	1
81	Washer	1
82	Screw	1
83	Key	1
84	Chuck	1
85	Clamp Bolt	1
86	Screw	1
87	Zero Mark	1
88	Table Arm	1
89	Table Bracket	2
90	Rivet	1
92	Gear	1
93	Worm	1
94	Angle Scale	1
95	Spindle	1
96	Arbor	1
97	Wedge	1
98	V Belt	1
99	Head Frame	1
100	Lamp Receptacle	1
102	Lock Ring, Shaft	1
103	Lock Ring, Pulley	1
104	Bearings	1
105	Central Pulley	1
106	Shaft	1
108	Shaft	1
109	Quill	1
110	Bearing	1
111	Ring	1

PARTS DIAGRAM

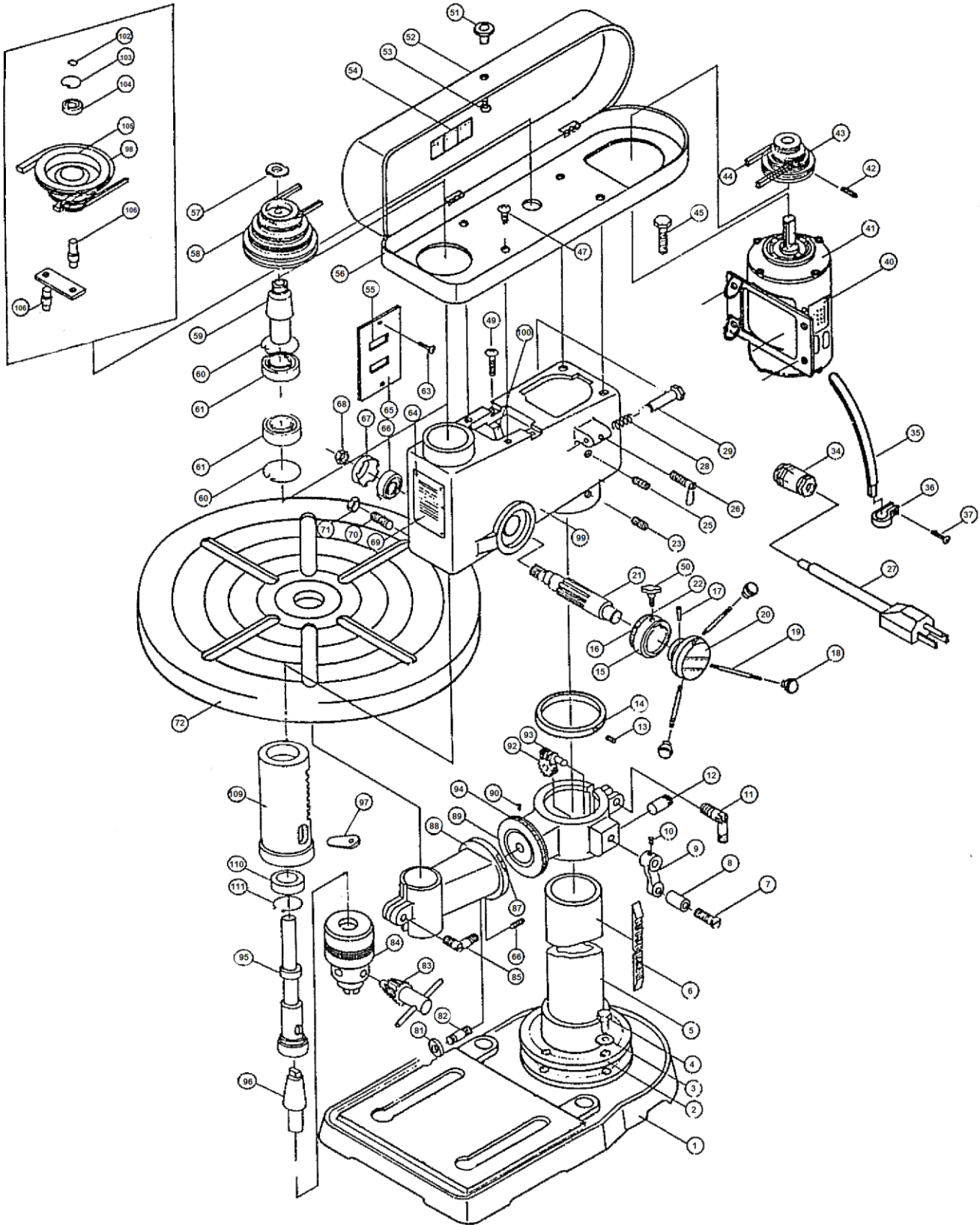

TROUBLESHOOTING

PROBLEM	POSSIBLE CAUSE	REMEDY
Noisy Operation	<ul style="list-style-type: none"> • Incorrect belt tension • Dry spindle • Loose pulley • Loose belt • Bad bearing 	<ul style="list-style-type: none"> • Adjust tension • Remove spindle/quill assembly & lubricate • Tighten pulley • Adjust belt tension • Replace bearing
Excessive drill wobble	<ul style="list-style-type: none"> • Loose chuck • Worn spindle shaft or bearing • Bad chuck 	<ul style="list-style-type: none"> • Tighten by pressing chuck down against table • Replace spindle shaft or bearing • Replace chuck
Motor won't start	<ul style="list-style-type: none"> • Power supply • Motor connection • Switch connections • Motor windings burnt • Bad switch 	<ul style="list-style-type: none"> • Check power cord • Check motor connections • Check switch connections • Replace motor • Replace switch
Drill binds in workpiece	<ul style="list-style-type: none"> • Excessive pressure on feed handle • Loose belt • Loose drill • Speed too fast 	<ul style="list-style-type: none"> • Apply less pressure • Check belt tension • Tighten drill with key • Change speed
Drill burns or smokes	<ul style="list-style-type: none"> • Incorrect speed – reduce RPM • Fillings caught in drill bit • Poor drilling • Incorrect feed pressure 	<ul style="list-style-type: none"> • Refer to RPM sheet • Clean drill bit • Sharpen drill bit or replace drill bit • Apply less pressure
Table difficult to raise	<ul style="list-style-type: none"> • Needs lubrication • Bent rack • Table lock too tight 	<ul style="list-style-type: none"> • Lubricate with a light oil • Straighten rack • Loosen clamp

WARRANTY

BORUM Industrial products have been carefully tested and inspected before shipment and are guaranteed to be free from defective materials and workmanship for a period of 12 months from the date of purchase except where tools are hired out when the guarantee period is ninety days from the date of purchase.

Should this piece of equipment develop any fault, please return the complete tool to your nearest authorised warranty repair agent or contact TQB Brands Pty Ltd Warranty team – warranty@tqbbrands.com.au.

If upon inspection it is found that the fault occurring is due to defective materials or workmanship, repairs will be carried out free of charge. This guarantee does not apply to normal wear and tear, nor does it cover any damage caused by misuse, careless or unsafe handling, alterations, accident, or repairs attempted or made by any personnel other than the authorised TQB Brands Pty Ltd repair agent.

This guarantee applies in lieu of any other guarantee expressed or implied and variations of its terms are not authorised.

Your TQB Brands Pty Ltd guarantee is not effective unless you can produce upon request a dated receipt or invoice to verify your proof of purchase within the 12month period.

Consumer Guarantee

Our goods come with a guarantee that cannot be excluded under the Australian Consumer Law. You are entitled to a replacement or refund for a major failure and compensation for any other reasonably foreseeable loss or damage. You are also entitled to have the goods repaired or replaced if the goods fail to be of acceptable quality and the failure does not amount to a major failure.



All images and illustrations shown are for reference purposes only. All information, specifications and illustrations in this manual are based on the latest information available at the time of publication and are subject to change without notice. The information in this manual is periodically revised to ensure the latest information is included. Download the latest version of this manual and other related technical documentation from www.tqbbrands.com.au